

OEL8000II Owner's Manual

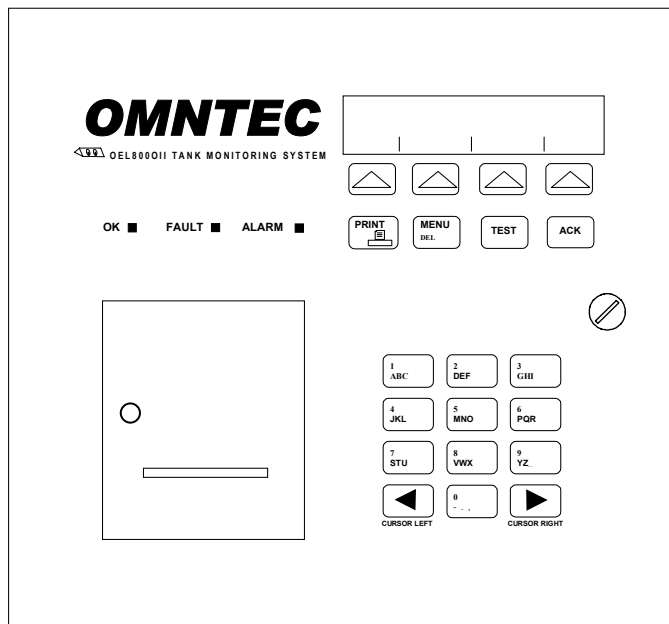

Version 5.33E August 2006



PROPRIETARY INFORMATION NOTICE

This document contains information and material developed by OMNTEC® Mfg., Inc. All rights are reserved.

No part of this document may be reproduced, transmitted, processed or recorded by any means or form, electronic, mechanical, photographic or otherwise, without the express written consent of OMNTEC® Mfg., Inc.

Printed in the United States of America

© Copyright 2007 OMNTEC® Mfg., Inc.

NOTICE

Use of unauthorized parts in the OEL8000II system or modification to any parts of the system will nullify U.L. listing and our warranty. OMNTEC[®] Mfg., Inc. will not be responsible for any liability claims arising from the performance of modified units.

If you have any questions, please contact OMNTEC[®] Mfg., Inc. at (631) 981-2001.

WARRANTY

The seller, OMNTEC Mfg., Inc. warrants to buyer that product is free of defects when properly installed and maintained by user. Warranty period is one year from date of installation or 15 months from date of shipment from factory, whichever occurs first. The seller's sole obligation is to repair or replace parts found to be defective upon evaluation by OMNTEC. Parts can be returned for evaluation by requesting an RMA (Return Material Authorization) from OMNTEC. The liability of the seller shall not exceed the price paid for components found to be defective. The above warranty is exclusive of all other warranties whether implied or expressed. Seller assumes no obligation for special or indirect damages incurred by user.

OMNTEC warranty for custom probes, custom controllers, add ons, spare or replacement parts is for 90 days from date of shipment. All items must be properly installed for warranty to be valid. Any items found to have factory defects after evaluation by OMNTEC through return material authorization process, will be repaired or replaced. The liability of seller shall not exceed price paid for item found to be defective by factory evaluation. The above warranty is exclusive of all other warranties whether implied or expressed. OMNTEC assumes no responsibility or obligation for special or indirect damages incurred by user.

Table of Contents

| | |
|---|------------|
| READ THIS FIRST! | XI |
| SECTION 1 INTRODUCTION | 1-1 |
| 1.1 THE OEL8000II | 1-1 |
| 1.2 ABOUT THIS MANUAL | 1-1 |
| 1.3 MANUAL CONVENTIONS..... | 1-2 |
| SECTION 2 SYSTEM DESCRIPTION | 2-1 |
| 2.1 MAIN FUNCTIONS..... | 2-1 |
| 2.2 SYSTEM COMPONENTS | 2-1 |
| 2.2.1 <i>Controller</i> | 2-1 |
| 2.2.1.1 Controller Front Panel Features..... | 2-2 |
| 2.2.1.2 Self Test..... | 2-2 |
| 2.2.1.3 Warnings, Alarms, and Setpoints..... | 2-3 |
| 2.2.1.4 Inventory Management..... | 2-5 |
| 2.2.1.5 Volumetric Leak Detection (VLD)..... | 2-6 |
| 2.2.1.6 System of Measurement..... | 2-6 |
| 2.2.1.7 Communications..... | 2-7 |
| 2.2.2 <i>Probes</i> | 2-7 |
| 2.2.3 <i>Sensors</i> | 2-7 |
| 2.2.4 <i>Optional Features</i> | 2-7 |
| 2.2.4.1 Annunciators (RAS-series Remotes)..... | 2-7 |
| 2.2.4.2 Interface Boards..... | 2-8 |
| 2.2.4.3 Remote Communications (OMNTEC-PC interactive software)..... | 2-8 |
| 2.2.4.4 Additional Options..... | 2-8 |
| SECTION 3 SYSTEM OPERATIONS | 3-1 |
| 3.1 CONTROL PANEL..... | 3-1 |
| 3.1.1 <i>LCD Display Screen</i> | 3-1 |
| 3.1.2 <i>LEDs</i> | 3-2 |
| 3.1.3 <i>Arrow Keys</i> | 3-2 |
| 3.1.4 <i>Function Keys (PRINT, MENU, TEST, and ACK)</i> | 3-2 |
| 3.1.4.1 PRINT Key..... | 3-3 |
| 3.1.4.2 MENU/DELETE Key..... | 3-3 |
| 3.1.4.3 TEST Key..... | 3-3 |
| 3.1.4.4 ACK Key..... | 3-4 |
| 3.1.5 <i>Data Keypad</i> | 3-4 |
| 3.1.6 <i>Printer</i> | 3-4 |
| 3.1.7 <i>Lock and Keys</i> | 3-5 |
| 3.1.8 <i>Horn</i> | 3-5 |
| 3.2 MENUS, SCREENS, AND PRINTOUTS..... | 3-5 |
| 3.2.1 <i>MAIN Menu</i> | 3-5 |
| 3.2.1.1 Screen #1 (MAIN Menu)..... | 3-6 |
| 3.2.1.2 Screen #2 (MAIN Menu)..... | 3-7 |
| 3.2.1.3 Screen #3 (MAIN Menu)..... | 3-8 |
| 3.2.1.4 Screen #4 (MAIN Menu)..... | 3-8 |
| 3.2.1.5 Screen #5 (MAIN Menu)..... | 3-9 |
| 3.2.1.6 Screen #6 (Main Menu)..... | 3-10 |
| 3.2.2 <i>Submenus</i> | 3-10 |
| 3.2.2.1 STATUS Submenu..... | 3-10 |
| 3.2.2.2 ALARMS Submenu..... | 3-15 |

| | | |
|--|---|------------|
| 3.2.2.3 | SETUP Submenu | 3-17 |
| 3.2.2.4 | TIME Submenu | 3-17 |
| 3.2.2.5 | ALRM LOG Submenu | 3-18 |
| 3.2.2.6 | ALRM PRNT Submenu..... | 3-19 |
| 3.2.2.7 | VLD Submenu..... | 3-19 |
| 3.2.2.8 | DROP E/D Submenu | 3-21 |
| 3.2.2.9 | PRNT DROP Submenu | 3-22 |
| 3.2.2.10 | TMP SNSR Submenu | 3-23 |
| 3.2.2.11 | SHIFT LOG Submenu | 3-24 |
| 3.2.2.12 | DIAG Submenu | 3-25 |
| 3.2.2.13 | PRINTER Submenu..... | 3-27 |
| SECTION 4 FUNCTIONS AND PROCEDURES | | 4-1 |
| 4.1 | BASIC FUNCTIONS AND PROCEDURES..... | 4-1 |
| 4.1.1 | <i>Printouts</i> | 4-1 |
| 4.1.1.1 | System Inventory Printout | 4-1 |
| 4.1.1.2 | Inventory Printout for Specific Tank | 4-1 |
| 4.1.1.3 | Printout of Alarms and Warnings in Effect..... | 4-1 |
| 4.1.1.4 | View/Print Alarm Log | 4-2 |
| 4.1.1.5 | Printout Drop Information | 4-2 |
| 4.1.1.6 | Printout Shift Log Report | 4-2 |
| 4.1.1.7 | Enable/Disable Automatic Printout for Alarm..... | 4-2 |
| 4.1.1.8 | Enable/Disable Automatic Printout upon Drop | 4-3 |
| 4.1.2 | <i>View Inventory Data</i> | 4-3 |
| 4.1.3 | <i>View Alarms Currently in Effect</i> | 4-3 |
| 4.1.4 | <i>System Setup</i> | 4-3 |
| 4.1.5 | <i>Changing the Date and Time</i> | 4-3 |
| 4.1.6 | <i>Perform VLD</i> | 4-4 |
| 4.1.7 | <i>Enable/Disable Communications</i> | 4-4 |
| 4.1.8 | <i>Testing Alarms for Product and Water</i> | 4-4 |
| 4.1.9 | <i>Data Direction</i> | 4-4 |
| 4.1.10 | <i>Remote Testing of RAS Annunciator</i> | 4-4 |
| 4.2 | RESPONDING TO ALARMS..... | 4-4 |
| 4.3 | FAULTS..... | 4-6 |
| 4.4 | TESTING SYSTEMS | 4-6 |
| 4.5 | LCD FIELDS IN MAIN MENU | 4-6 |
| SECTION 5 FAQ'S FOR OEL8000II..... | | 5-1 |
| FREQUENTLY ASKED QUESTIONS..... | | 5-1 |
| APPENDIX A INSTALLING THERMAL PAPER..... | | A-1 |
| A.1 INSTALLING THERMAL PAPER IN THE PRINTER..... | | A-1 |
| APPENDIX B ELECTRICAL RATINGS | | B-1 |
| B.1 ELECTRICAL RATINGS FOR THE OEL8000II | | B-1 |

Read This First!

The OEL8000II has been designed using intrinsically safe principals and is Underwriters Laboratories (U.L.) listed, CUL listed, and CE listed for petroleum storage tanks. It is approved for Class I, Groups C and D or Class I, Zone 0, Group IIB Hazardous locations when connected in accordance with control drawing number CDOEL8000II.



Do not attempt to make any other adjustments no matter how simple they may appear.

All work must be performed only by authorized personnel who are qualified using intrinsically safe design principles (NEC procedures) and are thoroughly familiar with the OEL8000II Installation Manual. At a minimum, it is the installer's responsibility to be familiar with and to comply with intrinsic design principles as defined in the *National Electrical Code*. It is also the installer's responsibility to be familiar with and to comply with applicable local codes.

Improper wiring or installation can compromise the intrinsically safe design of the system and create an electric shock or explosion hazard. YOU CAN CAUSE DEATH OR SERIOUS PERSONAL INJURY TO YOURSELF AND OTHERS AND EXTENSIVE PROPERTY DAMAGE.



Observe the following rules. Failure to do so will create an electric shock or explosion hazard that can result in death, personal injury, or property damage.

1. Do not install or service the equipment yourself.
2. Do not permit unauthorized personnel to install or service the equipment.

3. Power to the controller must be removed before installing or servicing the equipment.
4. The only adjustments that you are allowed to make are:
 - a. Loading the printer paper.
 - b. Programming the controller as described in this manual.

Section 1 INTRODUCTION

1.1 The OEL8000II

The OMNTEC® Mfg., Inc. OEL8000II is a comprehensive tank gauging and leak detection system designed to bring tank owners into compliance with EPA regulations. It provides real time simultaneous monitoring of up to eight tanks, identifying water and product levels. Up to forty-four additional sensors can be monitored for detecting discrete liquid levels and leaks. The OEL8000II is also an effective, user friendly, inventory management system that identifies usage and alerts the customer to low inventory.

The OEL8000II has been designed to be easy to use, but you can take full advantage of its capabilities by taking some time to read this manual. If you do nothing else, make certain that everyone who will have access to the controller reads the previous section – *Read This First!*

1.2 About this Manual

This manual is organized into five sections as follows:

| | | |
|------------------|--------------------------|---|
| Read This First! | | Users must read and understand this section thoroughly before reading the rest of this manual or using the OEL8000II. |
| Section 1 | Introduction | Introduces the OEL8000II system, discusses safety requirements, and describes the organization of the manual. |
| Section 2 | System Description | Describes the system features. |
| Section 3 | System Operations | Familiarizes the user with the OEL8000II front panel and describes the LCD's menus and submenus. |
| Section 4 | Functions and Procedures | Provides instructions for system functions and procedures. |
| Section 5 | FAQ's for OEL8000II | Provides answers to frequently asked questions. |

| | | |
|------------|--------------------------------------|--|
| Appendix A | Installing Thermal Paper | Provides instructions for replacing the printer's paper. |
| Appendix B | Electrical Ratings for the OEL8000II | Contains electrical rating data. |

1.3 Manual Conventions

This manual uses the following conventions:

- ◆ **Bold** indicates emphasis or heading.
- ◆ *Note* is used to set off important information from the rest of the text.

This manual also uses the following warning and caution formats:



The **WARNING** symbol alerts you to a hazard that may result death, personal injury, or property damage.



The **CAUTION** symbol alerts you that if directions are not properly followed, the system may not operate as expected.

Section 2 SYSTEM DESCRIPTION

2.1 Main Functions

The OMNTEC® Mfg., Inc. OEL8000II is an easy to use system that monitors underground and above ground storage tanks and piping systems. It is used with single wall and double wall steel or fiberglass tanks. Its two main functions are to detect leaks and to provide the owner with an efficient inventory monitoring system. A loud (up to 95 dB) horn and an LED (light emitting diode) on the controller panel are simultaneously activated to alert the owner when an alarm condition occurs. The LCD (liquid crystal display) identifies the cause and location of the alarm condition, and the controller's optional printer can be used to provide a permanent record of all data and alarm occurrences.

2.2 System Components

The OEL8000II consists of a controller panel and a combination of probes and sensors. The probes and sensors are installed in the storage tanks, interstitial spaces, piping sumps, double wall piping, dispenser pans, dykes, and observation wells for monitoring the tank contents and detecting leaks. These are connected to the controller via electrical cables that are run inside conduit. Unlike other types of electrical installations, special installation and wiring techniques are used by authorized installers who are qualified using intrinsically safe design principles (NEC procedures) and are familiar with the OEL8000II Installation Manual.



All installations and repairs must be performed by authorized installers. Do not attempt to perform any repairs yourself. Failure to comply may create an electric shock or explosion hazard that can result in death, personal injury, or property damage.

2.2.1 Controller

The controller is a programmable device that is wall-mounted within a non-hazardous area where it can be easily seen and heard. It monitors all of the probes and sensors and alerts the owner when a warning or alarm condition occurs (see Figure 3-1). If outdoor installation is required, an ENC-4X enclosure, heater, and thermostat are available. Contact OMNTEC® Mfg. Inc. for assistance.

2.2.1.1 Controller Front Panel Features

The following features are available or accessible at the Controller's front panel (see Figure 3-1).

Note: Some features must be enabled and/or programmed by an authorized installer.

◆ LCD

The LCD allows for easy programming of the controller, provides status and inventory data, and provides immediate identification of warning and alarm sources.

◆ Arrow Keys

The arrow keys are pushbuttons located below the LCD display. To select a field on the bottom line of the LCD, press the arrow key that points to the field. This will allow navigation through menus and select functions.

◆ Function Keys

Four function keys, located directly below the arrow keys (**PRINT**, **MENU**, **TEST**, and **ACK**), allow you to obtain printouts, return to the previous or MAIN Menu, delete characters on the LCD, initiate system test, and acknowledge alarms.

◆ Data Keypad

The data keypad resembles a telephone keypad containing alpha-numeric characters and is used for entering data. It also contains **CURSOR LEFT** and **CURSOR RIGHT** keys for positioning the cursor on the LCD.

◆ LEDs

Three LEDs are used to indicate system status (**OK**), detection of a fault condition (**FAULT**), and indication of an alarm condition (**ALARM**).

◆ Printer

A 36-character thermal printer can be activated manually or automatically to provide permanent records.

◆ Lock and Keys

The OEL8000II controller has with a lock to prevent internal tampering. The end-user is provided with two keys. Do not open the controller yourself. Only authorized and qualified professionals may service or install components in the OEL8000II system. Contact OMNTEC® Mfg. Inc. for replacement of lost keys.

2.2.1.2 Self Test

When activated by pressing the green **TEST** key on the controller panel, the self-test program will test various elements of the system including the RAM, EPROM, LCD, horn, front panel LED's, level probes, and the leak sensors. If an optional remote annunciator is installed, it will also test the annunciator by causing its lights to blink and horn to sound. The self-test feature includes an automatic printout (see Figure 2-1).

```

.
.
.
--- Testing PROM
Prom Tests OK

--- Testing RAM                PASSED
RAM tests OK

--- Testing Level Probes
T#  PRODUCT TYPE             TEST
T1  DIESEL                   P
T2  REGULAR                   P
.
.
.
T8  GAS                       P

--- Testing Leak Sensors
S#  P/N    LABEL             TEST
01  Bxls   T 1, Dbl_Wall#: 1  P
      (S/N: 000000001)
02  Bxls   T 2, Sump#: 1      P
      (S/N: 000000002)
03  BXPDS  T 3, Dispenser#: 1  P
.
.
.

```

Figure 2-1: Sample Self-Test Printout

2.2.1.3 Warnings, Alarms, and Setpoints

The OEL8000II controller will respond to certain conditions by initiating an alarm, warning condition, or a programmed response when the product level rises or drops to a specific setpoint.

The controller responds to a warning condition by displaying a message on its LCD. If the system includes a remote annunciator, its LED will flash.

In the event of an alarm, the controller will illuminate its red ALARM LED, activate its audible alarm, and display a message on its LCD. If the system includes a remote annunciator, its LED will illuminate and its audible alarm will also be activated. Pressing the **ACK** key on the controller's front panel will silence the horns, but the LEDs will remain illuminated, and the controller's LCD will continue to provide alarm data until the alarm condition has been eliminated.























| | High/High Level Alarm | Overfill Alarm* | High Warning | High Product Level | Low Product Level | Delivery Needed Alarm | Low/Low Level Alarm | High Water Alarm | Sensor Alarm | Sudden Loss Alarm | |
|---------------------------------|---|---|---|--------------------|-------------------|---|---|--|---|---|---|
| OEL8000II Piezo Horn |  |  | | | |  |  |  |  |  | |
| OEL8000II Alarm LED |  |  | | | |  |  |  |  |  | |
| OEL8000II LCD Display | X | X | X | | | X | X | X | X | X |  Audible Alarm |
| Remote Annunciator Flashing LED | | |  | | | | | | | |  Alarm LED |
| Remote Annunciator Solid LED |  |  | | | | | | | | |  Flashing LED |
| Remote Annunciator Horn |  |  | | | | | | | | |  Illuminated (solid) LED |
| IB-RB2 Relay Trigger Point | X | X | | X | X | | X | X | | | X Other Response |
| IB-12V Trigger Point | X | X | | X | X | | X | X | | | |

Table 2-1: Controller Alarm and Warning Response

* Factory disabled. End user can enable function and set alarm to trigger at any level up to 90%.

Following is a description of the system’s warnings, alarms and events. Table 2-1 shows how the system responds to these occurrences.

- ◆ High/High Level Alarm – occurs when the product level in the tank reaches an emergency height during a fill condition. The factory default value is 90%, but this can be adjusted up to 95%.
- ◆ Overfill Alarm – similar to High/High Level Alarm. It is factory disabled but can be enabled by the end user, and the trigger can be set at any level up to 90%.
- ◆ High Warning – occurs when the product level in the tank reaches the programmed high warning level.
- ◆ High Product Level – occurs when the product in the tank rises to the programmed high product level. This is a setpoint that can be used to initiate a programmed response such as triggering a relay. It is not a warning or an alarm.
- ◆ Low Product Level – occurs when the product in the tank drops to the programmed low product level. This is a setpoint that can be used to initiate a programmed response such as triggering a relay. It is not a warning or an alarm.
- ◆ Delivery Needed Alarm – occurs when the product level has dropped to a level at which point a delivery is needed.

- ◆ Low/Low Level Alarm – programmable feature, occurs when the product level in the tank drops to a critical level.
- ◆ High Water Alarm – programmable feature, it occurs when the water level in the tank is too high.
- ◆ Sensor Alarm – occurs when a leak has been detected.
- ◆ Sudden Loss Alarm – occurs during VLD testing indicating a large loss that is not consistent with a leak (e.g., pumping gas while test is in progress).

For all alarms, the LCD and the printer will identify the probe or sensor that initiated the alarm.

2.2.1.4 Inventory Management

The controller provides product volume data for each tank and maintains logs showing changes in inventory volume due to deliveries and usage during shifts.

◆ Inventory Increase Detection (DROP)

Inventory increase detection determines when a delivery is being made. This feature is automatically activated when the system detects an increase in volume that is in excess of a preprogrammed value. Upon activation, the system will wait for several minutes for the contents to settle and then store the data. The controller will store data for up to five deliveries per tank and up to forty (40) deliveries for the entire system. Afterwards, it will delete the oldest data each time a new delivery is made.

Note: To obtain an automatic printout following a delivery, the DROP mode must be enabled (see Section 3.2.2.8 – DROP E/D Submenu).



Do not dispense product from tank between delivery and printout. Failure to comply will yield false data.

◆ Shift Function

The Shift function is designed to automatically print tank volume information at the end of employee shifts. A printout is provided at the end of each employee shift to reflect that shifts start volume, end volume, and delta volume for each tank connected to the system. The Shift function can be designed for 1 to 4 different daily shift times. Below (see Figure 2-2) is an example of the automatic printout (in this case shift #1 begins at noon and ends at 8:00 PM).

Note: An authorized, qualified installer must program this feature. The installer should refer to the programming section in the OEL8000II Installation Manual.

| --- SHIFT REPORT | |
|----------------------|----------------------|
| Shift Number 1 | |
| End Time: | FR 02/02/07 20:00:00 |
| Start Time: | FR 02/02/07 12:00:00 |
| Tank 1, DIESEL | |
| End Product Level: | 34.01 (In) |
| Start Product Level: | 34.01 (In) |
| End Product Vol.: | 4724.23(G) |
| Start Product Vol.: | 4724.23(G) |
| End T.C. Vol.: | 4693.80(G) |
| Start T.C. Vol.: | 4692.51(G) |
| End Water Level: | 0.35 (In) |
| Start Water Level: | 0.35 (In) |
| End Water Vol.: | 49.15(G) |
| Start Water Vol.: | 49.15(G) |
| End Temperature: | 74.5(F) |
| Start Temperature: | 75.2(F) |
| Delivery Vol.: | 0.00(G) |
| Delivery T.C. Vol: | 0.00(G) |
| Sold/Used Vol.: | 0.00(G) |

Fig. 2-2: Sample Shift Report Printout

2.2.1.5 Volumetric Leak Detection (VLD)

Using the tank’s magnetostrictive probe, the controller performs a highly accurate volumetric leak detection test (VLD). The end user has the option of selecting the 0.1 gal/hour or the 0.2 gal/hour EPA standards for comparison purposes. A printout will provide the results of the comparison. The system stores the VLD data of the last thirty-two tests.

The automatic VLD feature is used for setting a specific time interval for running the VLD test. It can be run automatically every day, every week, or every month at a specific time of the day. Remember that the VLD test time is 4 hours long plus dwell time, and while the test is being conducted the product level must remain constant. This feature also automatically prints the VLD test results.

Note: The automated VLD feature must be enabled by an authorized installer as instructed in the programming section of the OEL8000II Installation Manual.

2.2.1.6 System of Measurement

The OEL8000II can be configured in the SETUP submenu to display data using either the standard English system of measurement or the Metric system, but not both.

2.2.1.7 Communications

The OEL8000II system features the following communication ports:

- ◆ (4) RS-232 ports – communication via PC.
- ◆ RS-485 – allows for connecting an optional remote digital display (RD625) that shows tank(s) volume.
- ◆ (1) Fax/Modem (optional) – allows for remote communication with controller using Omntec PC software.
- ◆ IB-Net Card (optional) – allows for faster remote communication with controller using Omntec PC software.
- ◆ Modbus – communication protocol.

2.2.2 Probes

The OEL8000II accepts up to 8 MTG (magnetostrictive) probes that will monitor product levels, water levels, and temperature in both underground and above-ground storage tanks.

2.2.3 Sensors

The OEL8000II accepts up to a maximum of 44 Bright Eye series sensors (BX-series). BX-sensors are built with four-wire buss technology, which allows up to 22 BX-sensors to be networked along the same cable on each buss line.

2.2.4 Optional Features

The OEL8000II functionality can be expanded with the installation of some of the optional features discussed below.

2.2.4.1 Annunciators (RAS-series Remotes)

Annunciators are high-level audiovisual remote alarm systems that can be mounted outdoors and in remote locations to ensure faster response to alarms. They should be installed in a non-hazardous location where they can be easily heard and seen by the filling operator. Their LED's flash when there is a high level warning. In case of a high level alarm, the LED stays lit and a 95 dB horn is activated. Annunciators that monitor more than one tank have an LED for each tank permitting immediate identification of the alarm source. For more detailed information, consult the OEL8000II Installation Manual.

2.2.4.2 Interface Boards

Optional alarm relays and low voltage annunciators can be integrated into the system to provide additional alert and control capability. The OEL8000II accepts up to six interface boards.

- ◆ Remote Annunciator Interface Boards (IB-RAS)
- ◆ Relay Boards (IB-RB2)
- ◆ Low Voltage Output Boards (IB-12V)
- ◆ 4-20 mA Card
- ◆ IB NET Board

2.2.4.3 Remote Communications (OMNTEC-PC interactive software)

Access to the system by computer allows for real time monitoring and downloading of status information to any remote location. For serial information sheets or software, contact Omntec Mfg.

2.2.4.4 Additional Options

- ◆ For systems that need to be mounted outside, NEMA 4X Enclosures, heaters and thermostats are available.
- ◆ Fax / Modem
- ◆ Downloadable Upgrades
- ◆ RD-625
- ◆ Modbus
- ◆ Pump/valve control systems

Section 3 SYSTEM OPERATIONS

3.1 Control Panel

The OEL8000II Controller is the heart of the entire system. In addition to monitoring probes and sensors, and providing warnings and alarms; it is used for programming the system, entering data, and retrieving data. The LCD display, LEDs, arrow keys, **PRINT** key, **MENU/DELETE** key, **TEST** key, **ACK** key, data keypad, printer, and panel lock are accessible on the Controller's front panel (see Figure 3-1).

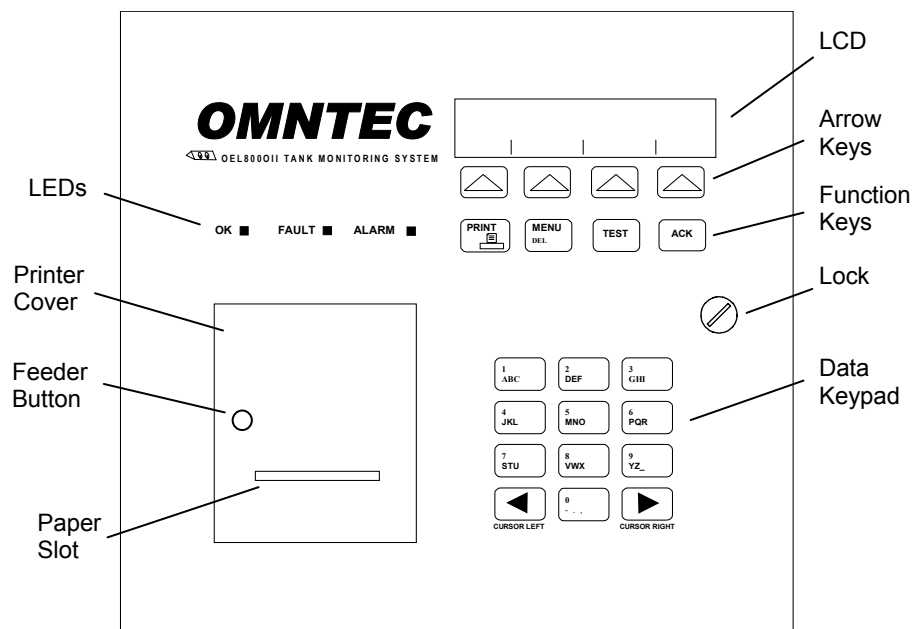

Fig. 3-1: OEL8000II Controller Front Panel

3.1.1 LCD Display Screen

The LCD features a four-line display with a maximum of forty characters per line. During normal operation, the LCD displays the Main Menu (see Figure 3-2).

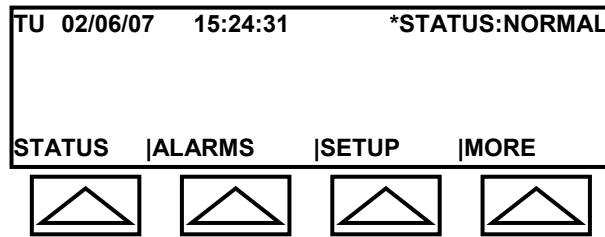

Fig. 3-2: LCD Display (Main Menu) with Arrow Keys

3.1.2 LEDs

Three LEDs located on left side of panel above the printer indicate the status of the system.

- ◆ OK – a green LED that is illuminated whenever the system status is in the NORMAL or SETUP mode as indicated in the top right corner of the LCD.
- ◆ FAULT – a red LED that illuminates if a problem occurs with the internal circuitry or flashes while the system is in diagnostic mode. If this LED lights up, contact your installer or the manufacturer.
- ◆ ALARM – a red LED that illuminates whenever an alarm condition occurs. The LCD will provide more specific information about the condition. It is extinguished only when the alarm condition is corrected.



All repairs must be performed by authorized installers. Do not attempt to perform any repairs yourself. Do not touch anything inside the panel. Failure to comply will create an electric shock or explosion hazard that can result in death, personal injury, or property damage.

3.1.3 Arrow Keys

Four upward pointing arrow keys point to the fields shown on the last line of the LCD display. Select a field by pressing the arrow that points to it. A field represents either a submenu or a function button. A submenu has its own screen or set of screens. A function is an action key, such as MORE, which scrolls through the screens within a menu.

3.1.4 Function Keys (PRINT, MENU, TEST, and ACK)

The **PRINT**, **MENU/DELETE**, **TEST**, and **ACK** keys are located directly below the arrow keys and have the following functions:

3.1.4.1 PRINT Key

Press the **PRINT** key to provide a printout of site data, alarm data for currently active alarms, and an inventory report.

3.1.4.2 MENU/DELETE Key

MENU and **DELETE** appear on the same key. While in a submenu, pressing this key will return the LCD to one of the four Main Menu screens. While entering data using the keypad, the same key can be used to delete a character.

*Note: Throughout the remainder of this manual, the term **MENU** key will be used when changing menus, and the term **DELETE** key will be used when deleting characters.*

To delete a character, simply move the cursor underneath the character (use the **CURSOR LEFT** or **CURSOR RIGHT** key) and press the **DELETE** key. If the cursor is under a blank space, pressing the **DELETE** key will move the cursor to the left and delete the character in that position.

*Note: You can exit a submenu by pressing the **MENU** key. If **EXIT** is displayed on the bottom line of the LCD, press the arrow key beneath it.*

3.1.4.3 TEST Key

Pressing the **TEST** key will activate the self-test feature. The system will test the following:

- ◆ RAM
- ◆ MTG Probes
- ◆ EPROM
- ◆ BX-series sensor
- ◆ LCD
- ◆ LEDs (LEDs on optional remote annunciator will also be tested, if installed)
- ◆ Horn (horn in optional remote annunciator will also be tested, if installed)

The controller will automatically determine if the RAM, Mag Probe, EPROM and BX-series sensor tests are successful. The user must determine if the LCD and LEDs are operational by visual observation, and if the horns are operational by listening to the controller and annunciators, if applicable.

Observe the LCD during the self-test operation. The controller will fill every space with a character starting with the number 1 and ending with the number 8. If you see any discrepancies, there may be a malfunction. Also observe the LEDs and listen to the horns on the controller and annunciator(s). If any of the LEDs fail to light up, or

if any of the horns fail to sound, there may be a malfunction. An automatic printout accompanies the self-test program.

There is an approximate 45-second delay between pressing the **TEST** key and the activation of the LEDs and horn(s). This should give you enough time to check the LEDs and horns on remote annunciators.



In the event of a malfunction, do not attempt to make any repairs yourself. Installation and servicing must be performed by authorized personnel only. Failure to comply will create an electric shock or explosion hazard that can result in death, personal injury, or property damage.

3.1.4.4 ACK Key

Press the **ACK** key to silence the horn upon the occurrence of an alarm. The **ALARM** LED will remain illuminated until the alarm condition has been corrected. If a value has been programmed for the Alarm Acknowledge Time (i.e., snooze alarm for controller), the horn will sound again after the elapsed time period providing the alarm condition still exists. This option can only be programmed by an authorized technician.

3.1.5 Data Keypad

The keypad resembles a telephone keypad and is used for entering data. You enter the number, letters, or characters shown on a key by pressing that key. For example:

- ◆ To enter the number **1**, press the key with the number **1** on it just one time.
- ◆ To enter the letter **A**, press the same key two times.
- ◆ To enter the letter **B**, press the same key three times.
- ◆ To enter the letter **C**, press the same key four times.

3.1.6 Printer

The printer is located at the lower left side of the panel. Printouts can be obtained by pressing the **PRINT** key or the arrow key beneath a print field when it appears on the bottom line of the LCD. The printer can also be programmed to provide automatic printouts under certain conditions such as the occurrence of an alarm and when an alarm is acknowledged. Automatic printouts can also be obtained of **DROP**, **Shift**, and **VLD** reports.

The **FEED** button on the printer is used to advance the paper. The message, **Paper is out** will appear on the LCD display when the paper runs out (to change paper, see *Appendix A – Installing Thermal Paper*).

Note: Red margins will appear on the printer paper when the paper is starting to run low. The paper must be replaced when the red margins start to fade.

3.1.7 Lock and Keys

The front panel contains a lock to prevent unauthorized personnel from accessing the inside of the controller. Two keys are provided with the system.

3.1.8 Horn

A horn located inside the controller provides an audible signal when an alarm condition occurs. It is silenced by pressing the **ACK** key.

3.2 Menus, Screens, and Printouts

The LCD displays a number of menus that provide different types of information and options for you to select. Because some menus have too many options to fit on the LCD display, they are divided into multiple screens. You can advance from one screen to the next by pressing the arrow key beneath the word **MORE**. When you find the option you are looking for, press the arrow key beneath it. When you get to the last screen of a menu, press the arrow beneath **MORE** to return to the first screen of that menu.

To get a hard copy printout of the information available within a particular menu, advance the screens until you find a **PRINT** field on the bottom line and press the arrow key beneath it.

Throughout the remainder of this manual, when you are instructed to select a field on the bottom line of the LCD, you must press the arrow key directly beneath that field.

3.2.1 MAIN Menu

The **MAIN** menu is divided into six screens. These screens provide the access points to all other menus and functions. Under normal operating conditions, the LCD displays Screen #1 (see Figure as shown in Figure 3-3a). The upper left corner (line #1) shows the day, date, and time, and the upper right corner shows the status. This will usually read **NORMAL**. The bottom line (line #4) allows you to select different options by using the corresponding arrow keys.

When the status is NORMAL, lines 2 and 3 will remain blank. If an alarm occurs and is acknowledged, the status will continue to show ALARM (see Figure 3-3b) until the condition is corrected.

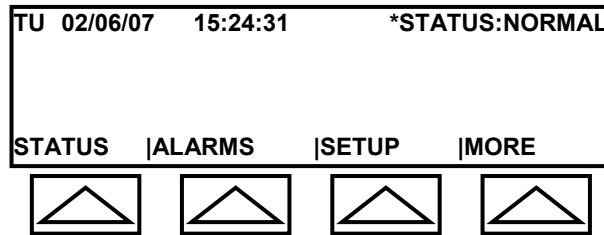

Fig. 3-3a: Main Menu – Screen #1 (Status: Normal)

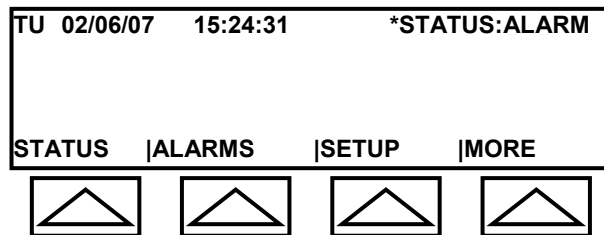

Fig. 3-3b: Main Menu – Screen #1 (Status: Alarm)

3.2.1.1 Screen #1 (MAIN Menu)

Screen #1 of the MAIN menu is displayed under normal operating conditions, and it is the starting point from where submenus and functions can be accessed. The bottom line provides the following options:

- ◆ STATUS – enters the STATUS submenu that provides data based on all probes and sensors that are connected to the controller and are enabled. This can include tank data, interstitial data, sump data, etc. (see *Section 3.2.2.1 – STATUS Submenu*).
- ◆ ALARMS – this submenu provides detailed information when an alarm occurs (see *Section 3.2.2.2 – ALARMS Submenu*).
- ◆ SETUP – enters the SETUP submenu to program the controller. The SETUP submenu may be accessed only by an authorized installer (see *Section 3.2.2.3 – SETUP Submenu*).
- ◆ MORE – advances to Screen #2 of the Main Menu, which provides additional options.

*Note: To return to a MAIN Menu screen, press the **MENU** key or select the **EXIT** function when it is displayed on the bottom line of the LCD.*

3.2.1.2 Screen #2 (MAIN Menu)

Selecting MORE on the bottom line of the LCD, advances the LCD to Screen #2 (see Figure 3-4a).

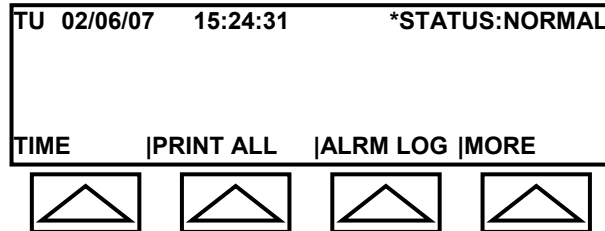

Fig. 3-4a: Main Menu – Screen #2 (Status: Normal)

The bottom line of the screen changes and provides the following additional options:

- ◆ TIME – allows you to program the current day, date, and time into the controller (see *Section 3.2.2.4 – TIME Submenu*).
- ◆ PRINT ALL – prints out an inventory report for all enabled tanks. It provides the current date and time and, for each tank, it provides: product type, product height, water height, gross volume, T.C. volume, water volume, ullage, and present temperature (see Figure 3-4b).
- ◆ ALARM LOG – displays the number of alarm entries in the alarm log and allows you to get a printout of the log (see *Section 3.2.2.5 – ALRM LOG*). The controller will store up to 128 alarm entries.

Note: Do not select PRINT LOG unless you actually want to print out all of its contents. To abort a printout, press the ACK key 3 times.

- ◆ MORE – advances to Screen #3 of the Main Menu, which provides additional options.

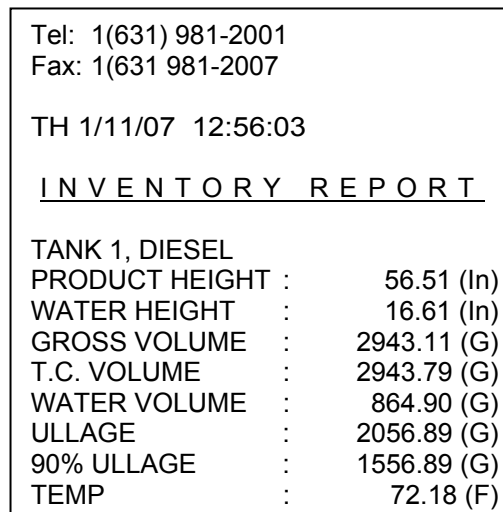

Figure 3-4b: PRINT ALL

Note: T.C. volume is temperature compensated volume. It is the gross volume (product plus water) at the industry standard temperature of 60°F.

3.2.1.3 Screen #3 (MAIN Menu)

Selecting MORE on the bottom line of the LCD, advances the LCD to Screen #3 (see Figure 3-5).

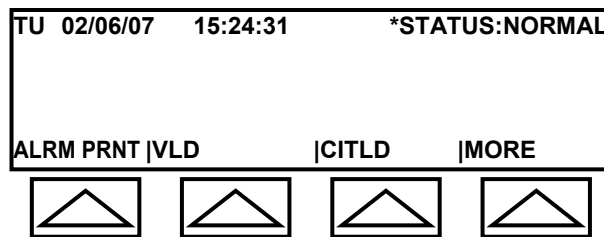

Fig. 3-5: Main Menu – Screen #3 (Status: Normal)

The bottom line of the screen changes and provides the following additional options:

- ◆ ALRM PRNT – permits enabling/disabling automatic printouts when an alarm events occur (see *Section 3.2.2.6 – ALRM PRNT Submenu*).
- ◆ VLD – enables/disables the on-demand, volumetric leak detection test (see *Section 3.2.2.7 – VLD Submenu*).
- ◆ CITLD – an optional feature for enabling Continuous In-Tank Leak Detection. It performs continuous (24-hour) in-tank leak detection by collecting data during tank idle time. Contact OMNTEC® Mfg., Inc. for additional information.
- ◆ MORE – advances to Main Menu Screen #4 for more options.

3.2.1.4 Screen #4 (MAIN Menu)

Selecting MORE on the bottom line of the LCD, advances the LCD to Screen #4 (see Figure 3-6).

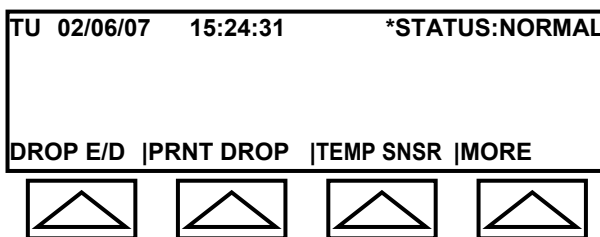

Fig. 3-6: Main Menu – Screen #4 (Status: Normal)

The bottom line of the screen changes and provides the following additional options:

- ◆ DROP E/D – permits enabling/disabling automatic printout whenever a delivery (DROP) occurs (see *Section 3.2.2.8 – DROP E/D Submenu*).
- ◆ PRNT DROP – permits obtaining a printout of the Delivery Log (see *Section 3.2.2.9 – PRNT DROP*).
- ◆ TEMP SNSR – optional feature that is displayed only if a temperature sensor is installed. It allows you to program the sensor’s dwell time (see *Section 3.2.2.10 – TEMP SNSR Submenu*).
- ◆ MORE – advances to Main Menu Screen #5 for more options.

3.2.1.5 Screen #5 (MAIN Menu)

Selecting MORE on the bottom line of the LCD, advances the LCD to Screen #5 (see Figure 3-7).

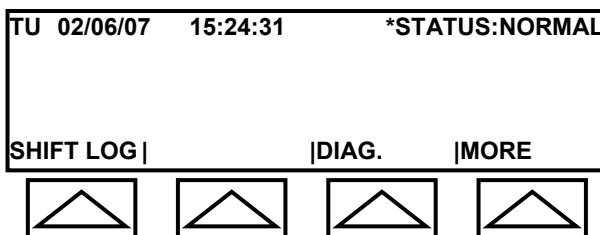

Fig. 3-7: Main Menu – Screen #5 (Status: Normal)

The bottom line of the screen changes and provides the following additional options:

- ◆ SHIFT LOG – allows you to print out a Shift Log report (see *Section 3.2.2.11 – SHIFT LOG Submenu*).
- ◆ DIAG. – allows you to enable/disable communications with remote sites and test alarms for product and water levels (see *Section 3.2.2.12 – DIAG. Submenu*).
- ◆ MORE – advances to Main Menu Screen #6 for more options.

3.2.1.6 Screen #6 (Main Menu)

Selecting MORE on the bottom line of the LCD, advances the LCD to Screen #6 (see Figure 3-8).

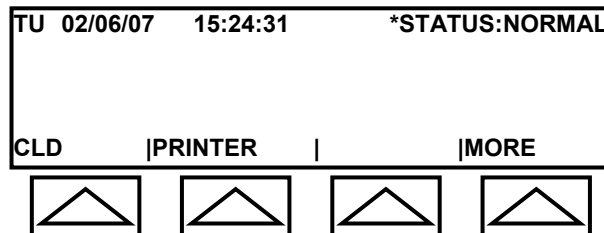

Fig. 3-8: Main Menu – Screen #6 (Status: Normal)

The bottom line of the screen changes and provides the following additional options:

- ◆ CLD – allows you to perform Continuous Leak Detection, and is primarily used for leak testing sump and dispenser containment areas. This feature is discussed in detail in the OEL8000II Installation Manual.
- ◆ PRINTER – displays a submenu that allows you set the print direction. The choices are: no actions, paper, LCD, comm2, and comm3 (see Section 3.2.2.13 – PRINTER Submenu).
- ◆ MORE – returns to Main Menu Screen #1.

3.2.2 Submenus

The submenus are examined in order of their occurrence starting from MAIN MENU screens #1 through #6 (STATUS, ALARMS, SETUP, TIME, ALRM LOG, ALRM PRNT, VLD, CITLD, DROP E/D, PRNT DROP, SHFT LOG, DIAG, CLD, PRINTER).

3.2.2.1 STATUS Submenu

The STATUS Submenu provides information based on the probes and sensors that are connected to the controller and have been enabled. This can include tank inventory data, where a magnetostrictive strobe has been installed, as well as interstitial data, sump data, temperature, etc. It also allows the user to enable or disable certain functions such as obtaining automatic printouts upon the occurrence of an alarm event or a delivery. Additional functions are discussed in the following subsections.

The STATUS Submenu is entered from Screen #1 of the MAIN Menu by selecting STATUS on the bottom line of the LCD. It is divided into five screens, and you advance to each screen by selecting MORE. To enhance readability, this manual has numbered the screens and discusses them in numerical order. Each time you enter the

STATUS Menu, however, you may start with a different screen. This is because system will enter at the last STATUS screen viewed.

*Note: While in the STATUS Submenu, pressing the **MENU** key will return the LCD to Screen #1 of the MAIN Menu.*

The bottom line in each of the five STATUS screens provide the following options:

- ◆ NEXT – increments the tank number, interstitial, sump, etc. When viewing tank data, for example, the same data will be shown for each enabled tank as the tank number is incremented by selecting NEXT.
- ◆ PREV – the opposite of NEXT. When viewing tank data, for example, the LCD will display the same data for the previous enabled tank as the tank number is decremented by selecting PREV.
- ◆ PRINT – provides an inventory report of the tank currently displayed on the LCD (See Figure 3-9). If sensor data is being displayed, it will provide the sensor number, description, serial number, and its location.
- ◆ MORE – advances to Screen #2 of the STATUS Submenu.

Note: Selecting NEXT allows viewing the same data for different tanks (or for different sensors). To view additional data for the same tank or sensor, select MORE.

```

Tel: 1(631) 981-2001
Fax: 1(631) 981-2007

TH 1/11/07 12:56:03

INVENTORY REPORT

TANK 1, DIESEL
PRODUCT HEIGHT :      56.51 (In)
WATER HEIGHT   :      16.61 (In)
GROSS VOLUME   :     2943.11 (G)
T.C. VOLUME    :     2943.79 (G)
WATER VOLUME   :      864.90 (G)
ULLAGE         :     2056.89 (G)
90% ULLAGE     :     1556.89 (G)
TEMP           :       72.18 (F)

```

Figure 3-9: PRINT

3.2.2.1.1 STATUS Submenu (Screen #1)

This manual chooses to label the following screen (see Figure 3-10) as Screen #1. This may not be the first screen that you will see when you select STATUS in the MAIN Menu. To follow along, repeatedly select MORE until you see the same screen.

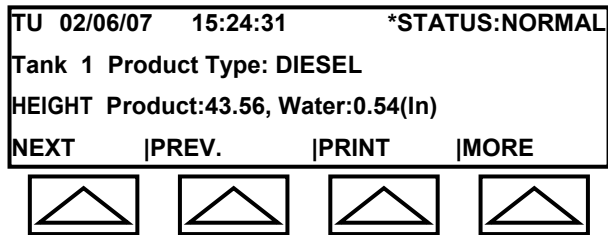

Fig. 3-10: Status Submenu – Screen #1

This screen provides product and water height data for the tank number shown. The top line remains unchanged showing the day, date, time, and status. The next two lines provide the following data:

- ◆ Product Type – describes the product in the tank such as Hi Test, Premium, Diesel, Regular, etc.
- ◆ HEIGHT – shows the levels in inches for the product and water. The Magnetostrictive (MTG) probe in the tank has a water float that indicates the actual height of the water. It also has a product float that indicates the height of all liquid in the tank, not the actual height of the product. The product height is calculated by subtracting the reading of the water float from the product float.

To view the same data for other tanks, press the arrow beneath NEXT.

Note: After all enabled tanks have been displayed, the LCD will show available sensor data and then go back to the first screen that was displayed..

3.2.2.1.2 STATUS Submenu (Screen #2)

Selecting MORE on the bottom line of the LCD, advances the LCD to Screen #2 (see Figure 3-11) of the STATUS Submenu.

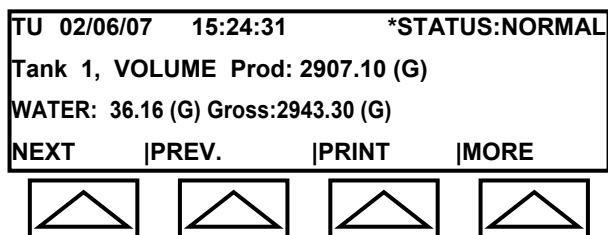

Fig. 3-11: Status Submenu – Screen #2

This screen provides product, water, and gross volume data for the tank number shown. The top line remains unchanged showing the day, date, time, and status. The next two lines provide the following data:

- ◆ VOLUME Prod – shows the product volume (gallons) in the tank.
- ◆ WATER – shows the volume of water (gallons) in the tank.
- ◆ Gross – shows the total volume (gallons) of liquid (product plus water) in the tank.

3.2.2.1.3 STATUS Submenu (Screen #3)

Selecting MORE on the bottom line of the LCD, advances the LCD to Screen #3 (see Figure 3-12) of the STATUS Submenu.

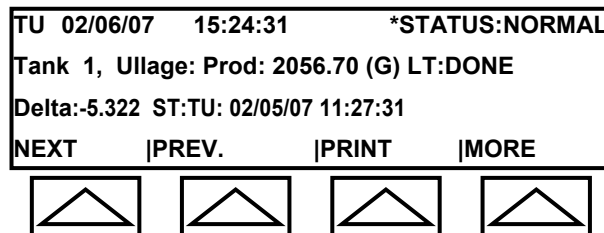

Fig. 3-12: Status Submenu – Screen #3

This screen provides ullage and volumetric leak detection (VLD) data for the tank number shown. The top line remains unchanged showing the day, date, time, and status. The next two lines provide the following data:

- ◆ Ullage – the amount of empty space (gallons) left in the tank.
- ◆ LT:DONE – shows that a volumetric leak test (LT) was done on this tank.
- ◆ DELTA – the difference in product gallons between the time the test was started and when it was concluded. The test duration is four hours plus dwell time.
- ◆ ST – shows the date and start time of the test.

3.2.2.1.4 STATUS Submenu (Screen #4)

Selecting MORE on the bottom line of the LCD, advances the LCD to Screen #4 (see Figure 3-13) of the STATUS Submenu.

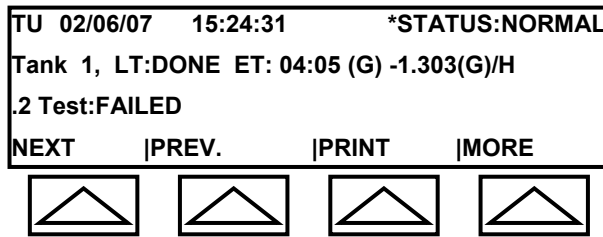

Fig. 3-13: Status Submenu – Screen #4

This screen provides data for the last VLD test performed for the tank number shown. The top line remains unchanged showing the day, date, time, and status. The next two lines provide the following data:

- ◆ LT:DONE – shows that a volumetric leak test (LT) was done on this tank. Other values are LT:ON (test is currently running) and LT:OFF (VLD is disabled).
- ◆ ET – refers to elapsed time. How long the test took to be completed. The adjacent value shows determined leak rate in gallons per hour.
- ◆ .2 TEST – shows that the 0.2 test was selected. The user may choose to run the 0.1 test or 0.2 test. The adjacent value shows whether the test passed or failed (in the above screen, the test failed).

3.2.2.1.5 STATUS Submenu (Screen #5)

Selecting MORE on the bottom line of the LCD, advances the LCD to Screen #5 (see Figure 3-14) of the STATUS Submenu.

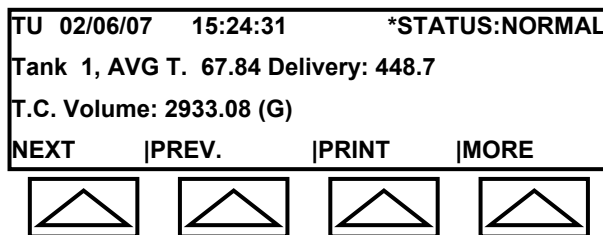

Fig. 3-14: Status Submenu – Screen #5

This screen provides the current average temperature, amount of the last delivery, and the temperature compensated volume for the tank number shown. The next two lines provide the following data:

- ◆ AVG T. – shows the current average temperature (°F) in the tank.
- ◆ T.C. – the calculated Temperature Compensated Product Volume to 60°F.

3.2.2.2 ALARMS Submenu

The ALARMS Submenu is entered from Screen #1 of the MAIN Menu by selecting ALARMS. It displays information pertaining to any alarms that currently exist.

If ALARMS is selected when there is no alarm or warning condition, the LCD will remain in Screen #1 of the Main Menu and the second line will display a message that there are no active alarms (see Figure 3-15a). This will be displayed for a few seconds and then cleared.

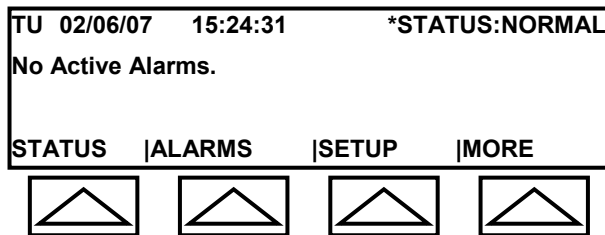

Fig. 3-15a: Main Menu – Screen #1 (Status: Normal)

When there is an active alarm or warning, selecting ALARMS will display the ALARMS Submenu. The LCD will alternate between two messages (see Figures 3-15b and 3-15c). The following figures assume the presence of a high water alarm.

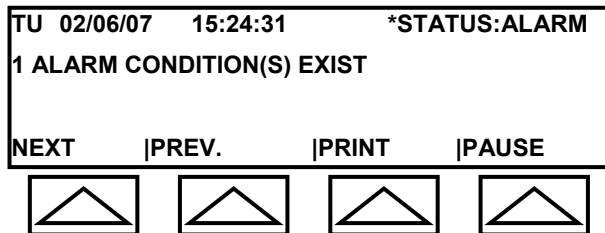

Fig. 3-15b: Alarms Submenu

The second line in the above screen indicates the number of alarms currently in effect.

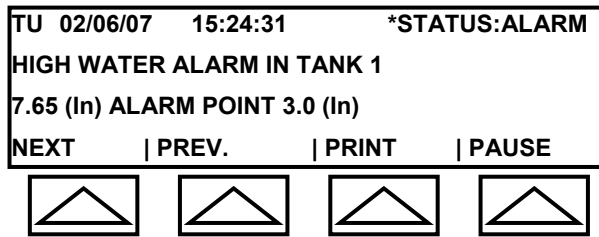

Fig. 3-15c: Alarms Submenu

The second line in the above screen identifies the alarm (high water level). The third line provides additional information about the alarm. In this case it shows the actual water level and the level at which the alarm was triggered.

The bottom line of the ALARMS Submenu provides the following additional options:

- ◆ NEXT – displays the next alarm that is currently in effect.
- ◆ PREV. – displays the previous alarm that is current in effect.
- ◆ PRINT – provides a printout of the Alarm Report (see Figure 3-16d).
- ◆ PAUSE – freezes the LCD and prevents it from alternating between the two screens shown above. Select NEXT or PREV. to resume alternating between the screens.

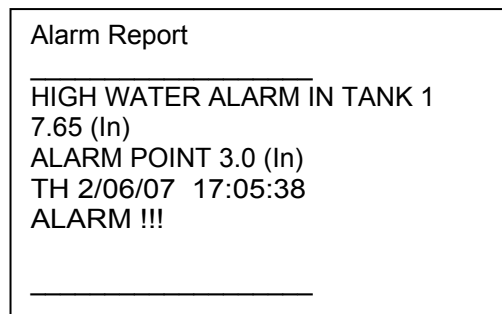

Figure 3-16d: Alarm Report

A printout of the Alarm Log can be obtained in the ALRM LOG Submenu (see *Section 3.2.2.5 – ALRM LOG Submenu*) that can be accessed in Screen #2 of the MAIN Menu. The Alarm Log can store up to 128 events. Also, the printer can be enabled (or disabled) to provide an automatic printout upon the occurrence of an alarm or warning in the ALRM PRNT Submenu (see *Section 3.2.2.6 ALRM PRNT Submenu*) that can be accessed in Screen #3 of the MAIN Menu.

3.2.2.3 SETUP Submenu

The SETUP Submenu is entered from Screen #1 of the MAIN Menu by selecting SETUP. This section is discussed in the OEL8000II Installation Manual, and it can be accessed only by authorized installers. Entry is blocked by a security code.

Authorized installers are required to be familiar with intrinsic design safety principles. DO NOT ATTEMPT TO CIRCUMVENT THE SECURITY CODE TO ACCESS THE SETUP SUBMENU.



Unauthorized entry into the SETUP Submenu can create a hazard that may result in death, personal injury, or property damage.

3.2.2.4 TIME Submenu

The TIME Submenu is entered from Screen #2 of the MAIN Menu by selecting TIME. It allows you to change the day, date, and time. When you enter the submenu, the second line displays **Adjust The Day of the Week**. The third line shows the cursor flashing on the day (see Figure 3-17).

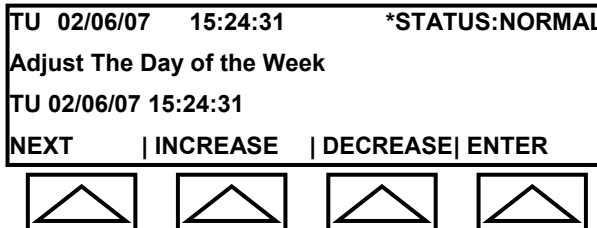

Fig. 3-17: Time Submenu

The bottom line of the TIME Submenu allows you to make changes to the time as follows:

- ◆ NEXT – to change a field, you must first move the cursor on the third line to the field. Selecting NEXT, moves the cursor to the next field to the right. The second line identifies the field (i.e., day, month, date, year, hour, minutes, second).
- ◆ INCREASE – select INCREASE to increase the value of the field where the cursor is currently positioned.
- ◆ DECREASE – select DECREASE to decrease the value of the field where the cursor is currently positioned.
- ◆ ENTER – select ENTER to save the changes and return to Screen #2 of the MAIN Menu.

Note: If you made no changes and wish to exit the TIME Submenu, select ENTER.

3.2.2.5 ALRM LOG Submenu

The ALRM LOG Submenu is entered from Screen #2 of the MAIN Menu by selecting ALRM LOG. It displays the number alarm entries in the alarm log (see Figure 3-18a), and allows you to obtain a printout of the log. Entries show when an alarm occurred and if and when it was cleared (see Figure 3-18b).

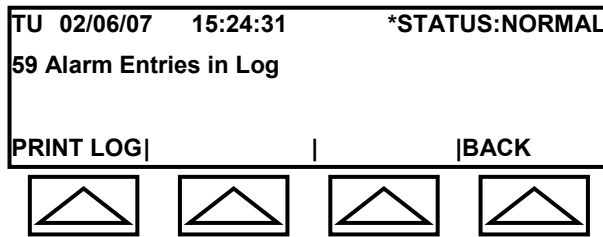

Fig. 3-18a: Alarm Log Submenu

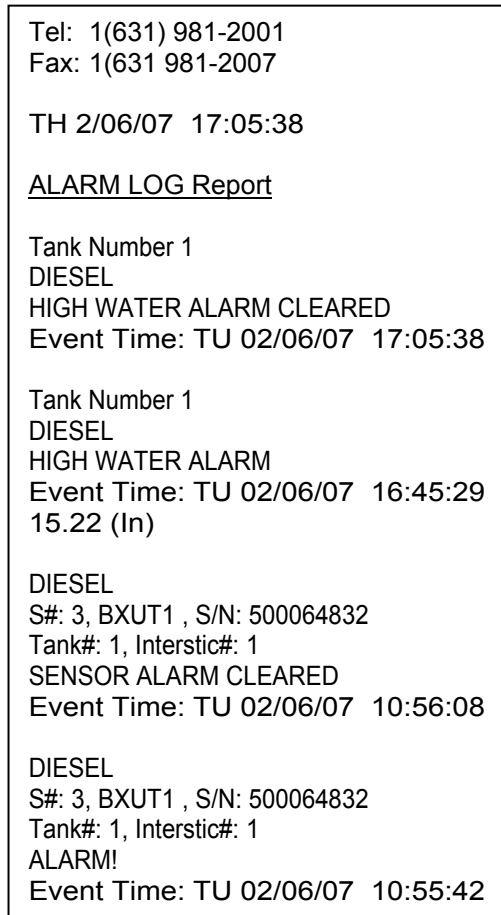

Figure 3-18b: Alarm Log

The bottom line of the ALRM LOG Submenu provides the following features:

- ◆ PRINT LOG – select PRINT LOG to obtain a printout of the alarm log.
- ◆ BACK – allows you to return to Screen #2 of the MAIN Menu.

*Note: The Alarm Log holds up to 128 entries. Do not select PRINT LOG unless you actually want to print out all of its contents. To abort a printout, press the **ACK** key 3 times.*

3.2.2.6 ALRM PRNT Submenu

The ALRM PRNT Submenu is entered from Screen #3 of the MAIN Menu by selecting ALRM PRNT (see Figure 3-19). It allows you to enable or disable the printer to provide an automatic printout (see Figure 3-16d) upon the occurrence of an alarm. A printout will also be automatically provided when the alarm is acknowledged.

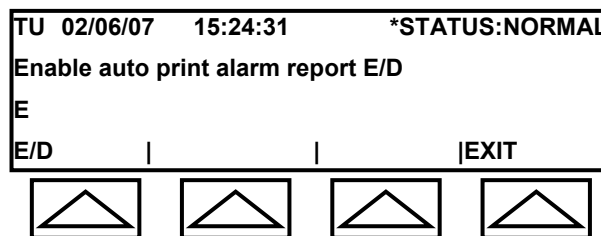

Fig. 3-19: Alarm Print Submenu

The bottom line of the ALRM PRNT Submenu provides the following features:

- ◆ E/D – allows toggling between **E** (enable automatic printout) and **D** (automatic printout).
- ◆ EXIT – returns to Screen #3 of the MAIN Menu.

3.2.2.7 VLD Submenu

The VLD Submenu is entered from Screen #3 of the MAIN Menu. It allows you to select a tank and start or stop the volumetric leak detection test (on-demand VLD testing). It also provides a PRNT LOG field (see Figure 3-20a) that can print out the VLD Log Data containing the last 32 reports. VLD testing is performed only on tanks with magnetostrictive probes.

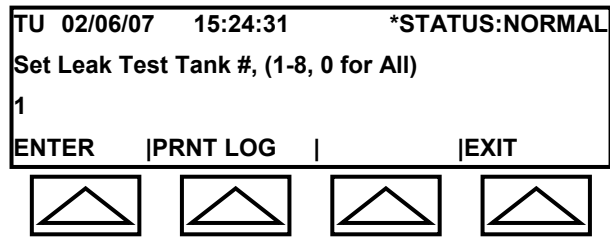

Fig. 3-20a: VLD Submenu

The bottom line of the VLD Submenu provides the following features:

- ◆ ENTER – after entering the desired tank to be tested using the keypad, select ENTER to start the test.
- ◆ PRNT LOG – provides a printout of the VLD Log Data (see Figure 3-20b).
- ◆ EXIT – returns to Screen #1 of the MAIN Menu.

The Volume Leak Detection test uses the tank’s magnetostrictive probes to monitor the tank’s contents. The average leak rate is calculated based on the detected product loss in gallons over a four hour period. This value is then compared to the 0.1 gallons per hour or 0.2 gallons per hour EPA leak rate standards. The standard is programmed in the SETUP Submenu.

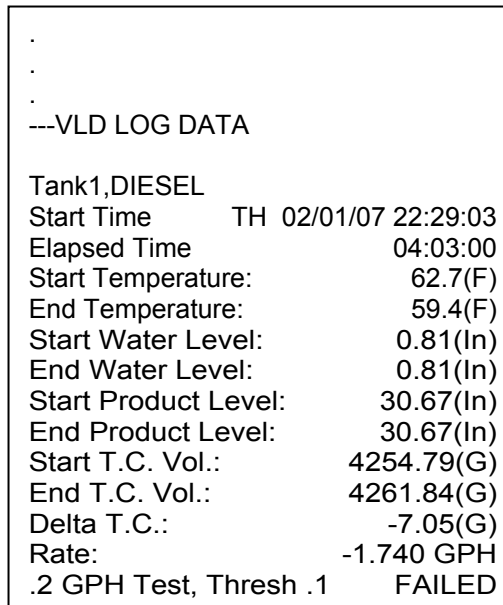

Figure 3-20b: VLD Log Data

Although the example below shows only one tank, the log will actually hold data for up to 32 reports. Once it has reached 32 reports, it will delete old data as new data is entered.

Procedure for running VLD tests

Before running a VLD test for a specific tank, wait four (4) hours after a delivery to allow the contents to settle. Also, the tank must remain inactive for about 4.5 hours while the test is in progress. This assumes the test has been programmed for 4 hours and the dwell time has been programmed for 0.5 hours.



Failure to comply with recommendations may result in incorrect data.

1. Select VLD in Screen #3 of the MAIN Menu. The VLD Submenu is displayed (see Figure 3-20a).
2. Using the keypad, enter a tank number (1 through 8 or enter 0 to select all tanks) and select ENTER. The test starts and the LCD returns to Screen #1 of the MAIN Menu.

Note: To exit the VLD Submenu without starting a test, select EXIT. The LCD return to Screen #1 of the MAIN Menu.

3. If you didn't choose all tanks (0) in Step 2, you can repeat Steps 1 and 2 for each additional tank to be tested. A printout will be provided when testing is completed (see Figure 3-20b).

Note: VLD in Screen #3 functions as a toggle. Selecting it while a VLD test is in progress will stop the test.

3.2.2.8 DROP E/D Submenu

The DROP E/D Submenu (see Figure 3-21) is entered from Screen #4 of the MAIN Menu. It permits enabling or disabling the printer to provide an automatic printout whenever a delivery (DROP) occurs. The system can store drop data for up to five drops per tank and a maximum of 40 drops for all tanks in the system.

The second line in the LCD indicates that automatic printout can be enabled or disabled by selecting E or D. The third line indicates the current status. In the example below, automatic printout is enabled.

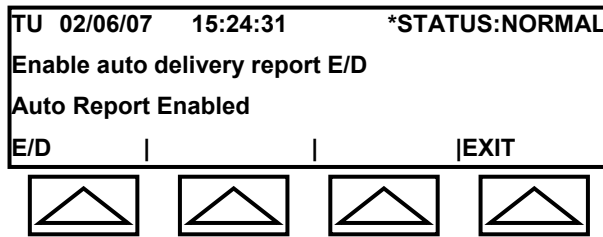

Fig. 3-21: Drop E/D Submenu

The bottom line of the DROP E/D Submenu provides the following features:

- ◆ E/D – allows toggling between **E** (enable automatic printout) and **D** (automatic printout).
- ◆ EXIT – returns to Screen #4 of the MAIN Menu.

3.2.2.9 PRNT DROP Submenu

The PRNT DROP Submenu (see Figure 3-22a) is entered from Screen #4 of the MAIN Menu. It displays a menu that allows you to select LAST DROP, which prints data for the most recent delivery (see Figure 3-22b), or ALL DROPS, which prints all stored data (up to five drops for each tank and up to 40 drops for the entire system).

The second line on the LCD indicates the number of entries currently stored in the system.

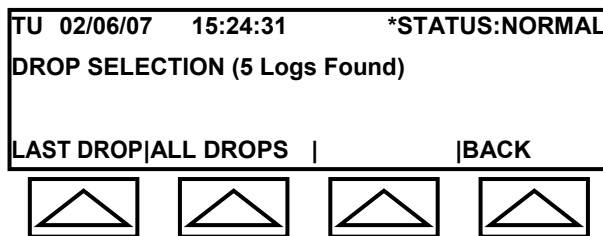

Fig. 3-22a: Print Drop Submenu

The bottom line of the DROP E/D Submenu provides the following features:

- ◆ LAST DROP – provides printout of the last delivery (see Figure 3-22b).
- ◆ ALL DROPS – provides printout of all drops in log (maximum of 5 drops per tank and 40 drops for the entire system).
- ◆ BACK – returns to Screen #4 of the MAIN Menu.

| ---Delivery Log | |
|----------------------|----------------------|
| TANK 1 | |
| PRODUCT TYPE | :DIESEL |
| Start Time: | TH 01/11/07 12:00:01 |
| Stop Time: | TH 01/11/07 12:30:54 |
| Start T.C. Vol.: | 2666.06(G) |
| Start Gross Vol.: | 2673.27(G) |
| Start Water Vol.: | 191.37(G) |
| Start Product Level: | 39.56 (In) |
| Start Water Level: | 2.83 (In) |
| Start Temperature: | 66.47(F) |
| End T.C. Vol.: | 3942.33(G) |
| End Gross Vol.: | 3952.66(G) |
| End Water Vol.: | 1777.76(G) |
| End Product Level: | 58.50 (In) |
| End Water Level: | 26.31 (In) |
| End Temperature: | 66.98(F) |
| Delta Gross: | 1279.35(G) |
| Delta T.C.: | 1276.27 (G) |

Figure 3-22b: Delivery Log

3.2.2.10 TMP SNSR Submenu

The TMP SNSR Submenu (see Figure 3-23) is entered from Screen #4 of the MAIN Menu. It permits you to program the dwell time (in minutes) for the optional temperature sensor. This is an optional feature that can be used for monitoring temperature in locations such as refrigerators and freezers.

The second line of the LCD prompts you to enter the dwell time on the third line using the data keypad.

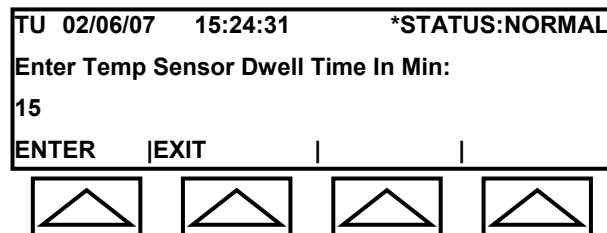

Fig. 3-23: Temperature Sensor Submenu

The bottom line of the TMP SNSR Submenu provides the following features:

- ◆ ENTER – enter the new dwell time using the data keypad then select ENTER to save new setting and return to Screen #4 of the MAIN Menu.
- ◆ EXIT – returns to Screen #4 of the MAIN Menu.

3.2.2.11 SHIFT LOG Submenu

The SHIFT LOG Submenu (see Figure 3-24a) is entered from Screen #5 of the MAIN Menu. It allows you to obtain a printout of the Shift Report (see Figure 3-24b). The Shift Report provides an inventory report only for enabled tanks and for the specified shift(s).

The second line of the LCD prompts you to enter the number of shifts to be printed (maximum is 18), and you enter the number on the third line using the data keypad.

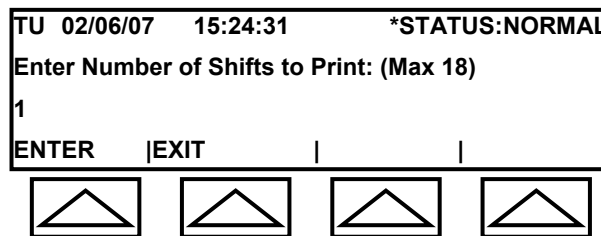

Fig. 3-24a: Shift Log Submenu

The bottom line of the SHIFT LOG Submenu provides the following features:

- ◆ ENTER – enter the number of shifts to be printed using data keypad then select ENTER to print the report and return to Screen #5 of the MAIN Menu.
- ◆ EXIT – returns to Screen #5 of the MAIN Menu.

| | |
|----------------------|----------------------|
| .---Shift Log | |
| End Time | FR 02/02/07 18:00:00 |
| Start Time | TH 02/01/07 12:00:00 |
| Tank1, DIESEL | |
| End Product Level: | 43.56(In) |
| Start Product Level: | 43.60(In) |
| End Product Vol.: | 2942.97(In) |
| Start Product Vol.: | 2945.66(In) |
| End T.C. Vol.: | 2934.10(G) |
| Start T.C. Vol.: | 2935.80(G) |
| End Water Level: | 2.90(In) |
| Start Water Level: | 2.85(In) |
| End Water Vol.: | 195.68(In) |
| Start Water Vol.: | 192.68(In) |
| End Temperature: | 67.2(F) |
| Start Temperature: | 68.0(F) |
| Delivery T.C. Vol.: | 0.00(G) |
| Sold/Used Vol.: | 2.70(G) |

Figure 3-24b: Shift Log Data

3.2.2.12 DIAG Submenu

The DIAG Submenu (see Figure 3-25a) is entered from Screen #5 of the MAIN Menu. It allows you to enable/disable communications with remote sites and test alarms for product and water levels

The second and third lines indicate whether CALLOUT is enabled or disabled. At times, it may be necessary to prevent the system from calling out. This is because the system will prevent access to its controls while a callout is in progress. To avoid being locked out of the system while working on it, you can disable callout until work is finished.

The second and third lines also identify the current setting for DIAG MODE (diagnostic mode): DIAG-Prod (diagnostics for product), DIAG-Water (diagnostics for water), and DIAG-OFF (diagnostic mode is off).

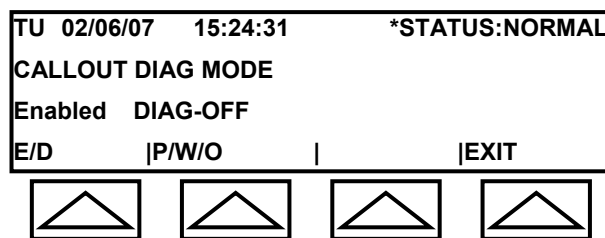

Fig. 3-25a: DIAG Submenu (Off)

The bottom line of the DIAG Submenu provides the following features:

- ◆ E/D – Enables/Disables callout. It permits toggling between enabling and disabling callout. To prevent lockout from system control while callout is in progress, disable callout. Select E/D again to enable callout.

Note: While callout is disabled, the system will not be able to communicate with remote sites. If you require this capability, make certain to re-enable callout when you have completed work.

- ◆ P/W/O – permits testing alarms to ensure that they will trigger when product or water reaches programmed levels. Repeatedly selecting this field will cycle through product, water, and off. When you select OFF, the LCD will display Figure 3-25a. When you select water, it will display Figure 3-25b, and when you select product, it will display Figure 3-25c.
- ◆ EXIT – returns to Screen #5 of the MAIN Menu.

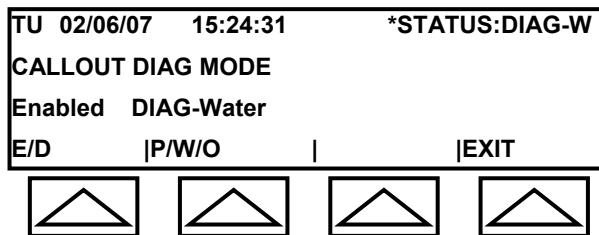

Fig. 3-25b: DIAG Submenu (Water)

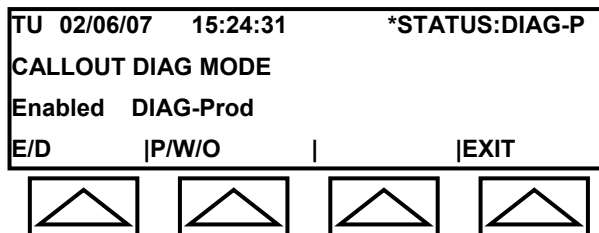

Fig. 3-25c: DIAG Submenu (Product)

Procedure for running P/W/O

To perform a test:

1. Select water or product. LCD will display selected test (see Figures 3-25b and 3-25c).
2. Select EXIT.
3. Press the **MENU** key.
4. Select STATUS. The LCD will display the volume for water or product (whichever you selected in Step 1).

5. Use the CURSOR LEFT key or CURSOR RIGHT key to adjust height until alarm sounds.
6. Press the **ACK** key to acknowledge alarm and silence horn.
7. Return to the DIAG submenu screen, and select O (off), and select EXIT to exit the submenu. The height levels will return to their actual settings.

Note: If no keys are pressed on the controller panel for 15 minutes, the system will automatically exit DIAG. and height levels will return to actual settings.

3.2.2.13 PRINTER Submenu

A number of menus provide access to the PRINTER Submenu (see Figure 3-26) that allows you to determine where data is sent. Choose the preferred option by entering a number with the data keypad.

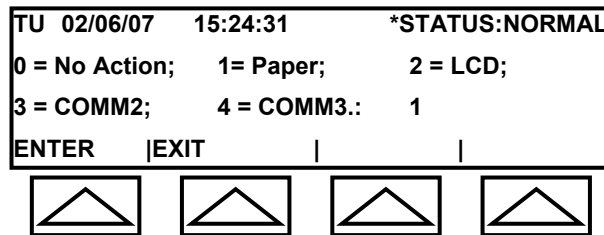

Fig. 3-26: Printer Submenu

The bottom line of the PRINTER Submenu provides the following features:

- ◆ ENTER – choose an option by entering its number using the data keypad then select ENTER. LCD returns to Screen #1 of the MAIN Menu.
- ◆ EXIT – returns to Screen #1 of the MAIN Menu.

Section 4 FUNCTIONS and PROCEDURES

4.1 Basic Functions and Procedures

This section identifies commonly used functions and either provides instructions or directs you to the proper subsection in *Section 3 – System Operations* for additional information.

4.1.1 Printouts

The following provides instructions for obtaining printouts and enabling/disabling printer for automatic printouts.

4.1.1.1 System Inventory Printout

Select PRINT ALL in Screen #2 of the MAIN Menu to obtain an inventory printout of each enabled tank in the system. Pressing the **PRINT** key will provide an inventory report as well as an alarm report for currently active alarms.

4.1.1.2 Inventory Printout for Specific Tank

Starting in Screen #1 of the MAIN Menu, do the following:

1. Select STATUS. The STATUS Submenu is displayed (see *Section 3.2.2.1.5 – STATUS Submenu*).
2. Repeatedly select NEXT to find the desired tank.
3. Select PRINT.

4.1.1.3 Printout of Alarms and Warnings in Effect

Starting in Screen #1 of the MAIN Menu, do the following:

1. Select ALARMS. The ALARMS Submenu is displayed (see *Section 3.2.2.2 – ALARMS Submenu*).
2. Select PRINT.

4.1.1.4 View/Print Alarm Log

Starting in Screen #1 of the MAIN Menu, do the following:

1. Select MORE to advance to Screen #2.
2. Select ALRM LOG. The ALRM LOG Submenu is displayed (see *Section 3.2.2.5 – ALRM LOG Submenu*).
3. Select PRINT LOG.

4.1.1.5 Printout Drop Information

You can obtain a printout of the last drop or the entire log. The log can hold data for up to 5 drops per tank up to 40 drops for the entire system.

Starting in Screen #1 of the MAIN Menu, do the following:

1. Select MORE (four times) to advance to Screen #5.
2. Select PRNT DROP to enter the PRNT DROP Submenu (see *Section 3.2.2.9 – PRNT DROP Submenu*).
3. Select LAST DROP for printout of most recent drop, or ALL DROPS to printout contents of the entire log.

4.1.1.6 Printout Shift Log Report

Starting in Screen #1 of the MAIN Menu, do the following:

1. Select MORE (four times) to advance to Screen #5.
2. Select SHIFT LOG. The SHIFT LOG Submenu (see *Section 3.2.2.11 – SHIFT LOG Submenu*) is displayed.
3. Enter the number of shifts to be printed using the data keypad then select ENTER.

4.1.1.7 Enable/Disable Automatic Printout for Alarm

The printer can be enabled or disabled to provide an automatic printout upon the occurrence of an alarm.

Starting in Screen #1 of the MAIN Menu, do the following:

1. Select MORE (two times) to advance to Screen #3.

2. Select ALRM PRNT to enter the ALRM PRNT Submenu (see *Section 3.2.2.6 – ALRM PRNT Submenu*).
3. Select E/D to toggle between enable and disable.

4.1.1.8 Enable/Disable Automatic Printout upon Drop

The printer can be enabled or disabled to provide an automatic printout after a delivery (drop).

Starting in Screen #1 of the MAIN Menu, do the following:

1. Select MORE (three times) to advance to Screen #4.
2. Select DROP E/D to enter the DROP E/D Submenu (see *Section 3.2.2.8 – DROP E/D Submenu*).
3. Select E/D to toggle between enable and disable.

4.1.2 View Inventory Data

In Screen #1 of the MAIN Menu, select STATUS (see *Section 3.2.2.1 – STATUS Submenu*).

4.1.3 View Alarms Currently in Effect

In Screen #1 of the MAIN Menu, select ALARMS (see *Section 3.2.2.2 – ALARMS Submenu*).

4.1.4 System Setup

System setup occurs in the SETUP Submenu, which is discussed in the OEL8000II Installation Manual. It is accessible only to authorized, qualified personnel.

4.1.5 Changing the Date and Time

The data and time are changed in the TIME Submenu. In Screen #2 of the MAIN Menu, select TIME (see *Section 3.2.2.4 – TIME Submenu*).

4.1.6 Perform VLD

On-demand VLD testing (Volumetric Leak Detection) can be manually enabled or disabled by toggling VLD in Screen #3 of the MAIN Menu. The procedure is provided in *Section 3.2.2.7 – VLD Submenu*.

4.1.7 Enable/Disable Communications

While remote communication is in effect, access to system controls is inhibited. To prevent being locked out of system while working, disable communications. Starting in Screen #1 of the MAIN Menu, do the following:

1. Select MORE (four times) to advance to Screen #5.
2. Select DIAG. The DIAG Submenu (see *Section 3.2.2.12 –DIAG Submenu*) is displayed.
3. Select E/D to enable or disable communications.

4.1.8 Testing Alarms for Product and Water

Alarms are tested by adjusting the product or water height until alarm is triggered (see *Section 3.2.2.12 – DIAG Submenu*).

4.1.9 Data Direction

Choose where data is to be sent (i.e., printer, lcd, etc). The procedure is provided in *Section 3.2.2.13 – PRINTER Submenu*.

4.1.10 Remote Testing of RAS Annunciator

The RAS Annunciator is always tested whenever the **TEST** key is selected on the controller's front panel. For remote testing, press and release the horn silence button on the annunciator itself. Lights will blink and horn will sound on both the controller and the annunciator.

4.2 Responding to Alarms

The following procedure describes how to respond to alarms and retrieve alarm data.

- When the green **OK** LED is illuminated, the system is operating properly and no alarm conditions exist.

OK FAULT ALARM

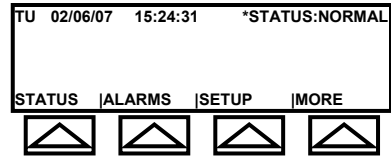

- When an alarm condition occurs:

- ◆ Horn will sound.
- ◆ Red **ALARM** LED illuminates.
- ◆ LCD shows status as **ALARM**. Remaining displays alternates between showing the number of alarms and identifying the individual alarms.
- ◆ If auto print is enabled (see *Section 3.2.2.6 – ALRM PRNT Submenu*), system will provide an automatic printout.

OK FAULT ALARM

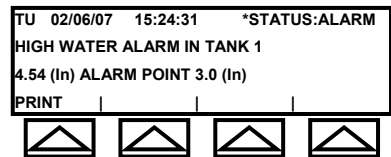
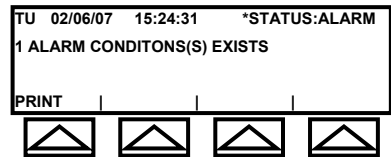

- Press **ACK** to silence the horn.

- ◆ Horn will silence.
- ◆ LCD will clear and LCD will continue to display **STATUS:ALARM**.
- ◆ If auto print is enabled, system will print the date and time of acknowledgment.

OK FAULT ALARM

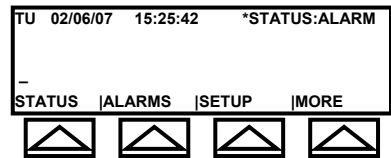

- To review alarms on the LCD, select **ALARMS** in Screen #1 of the MAIN Menu. To obtain a printout, select **ALARMS** in Screen #1 of Main Menu then select **PRINT** in the **ALARMS** Submenu.

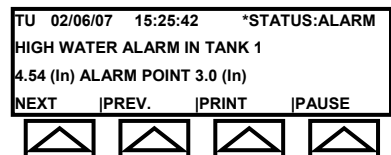

- The red **ALARM** LED will remain illuminated and the LCD will display **STATUS:ALARM** until all alarm conditions have been corrected.

OK FAULT ALARM

- Report all alarm conditions immediately to site manager:_____.

4.3 Faults

A system failure is indicated when the red **FAULT** LED is illuminated. Consult a authorized service contractor immediately:_____.

OK **FAULT** ALARM

4.4 Testing Systems

To test system, press the **TEST** key. The OEL8000II will test the controller, sensors, probes, and remote annunciators and print out a status report.

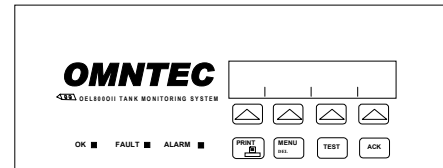

Every Alarm, fault, and test should be recorded, date, and signed in a log.

For authorized service contractor, please contact OMNTEC at 631-981-2001.

4.5 LCD Fields in MAIN Menu

1. Status – shows tank data.
2. Alarms – shows alarms and warnings currently in effect.
3. Setup – enters programming. Accessible only to authorized personnel.
4. Time – set the systems date and time.
5. Print All – provides an inventory report of all enabled tanks.
6. Alarm Log – provides printout of alarm log report.
7. Alarm Print – enables printer to provide an automatic printout upon occurrence of an alarm event.
8. VLD – enters volumetric leak detection procedure.
9. CITLD – Continuous In-Tank Leak Detection. Contact OMNTEC® Mfg., Inc. for additional information.
10. Drop E/D – enables printer to provide an automatic printout following a delivery.
11. Print Drop – provides printout of last drop or of the entire drop log (up to 5 drops per tank and a maximum of 40 drops for the entire system).

12. Temp Sensor – if installed in system, allows programming of dwell time in minutes.
13. Shift Log – prints shift log.
14. Diag – enables/disables callout and tests alarm levels for product and water.
15. CLD – Continuous Leak Detection. Discussed in the OEL8000II Installation Manual.
16. Printer – directs data to printer, LCD, etc.

Section 5 FAQ's for OEL8000II

Frequently Asked Questions

The following are frequently asked questions and answers for the OEL8000II:

Q1. What cable should be used for tanks and sensors?

A1. Belden 8761 for probes (a must) and Belden 9940 for sensors (recommended).

Q2. What batteries are used in the system?

A2. cr2032 (two batteries).

Q3. What type of paper is used in the printer?

A3. Thermal paper: 2 1/4" width, 3/8" core, and 1 1/2" diameter.

Q4. How do you test the printer engine?

A4. Turn controller off. Press and hold down the feed button then turn the controller back on with finger still on the feed button. Wait for printout.

Q5. How do you clear RAM in the controller?

A5. While observing the LCD, press and release the S2 reset button on the upper left-hand corner of the motherboard. As soon as you observe activity on the LCD, press and hold down the number 5 key on the data keypad. When the LCD displays:

WAITING TO CLEAR RAM

TO CLEAR RAM, RELEASE KEY

release the key immediately. **Do not wait 5 seconds as displayed on the LCD.**

Q6. Can sensor locations and parameters be changed?

A6. Only in Setup. This can be accessed only by authorized personnel.

Q7. What does sudden loss alarm refer to?

A7. Product was dispensed during VLD test.

Q8. How do you clear sudden loss alarm on the LCD?

A8. Clear RAM.

Q9. Is it necessary to reprogram system after clearing RAM?

A9. No. Programming will remain.

Q10. Where can the controller's serial number be found?

A10. Inside the door, below the lock. It begins with **EL** and is followed by 6 digits.

Q11. How do you change the date and time?

A11. In Screen #1 of the MAIN Menu, select MORE to advance to Screen #2 then select TIME and follow screen instructions.

Q12. What is a bus alarm?

A12. It is a sensor alarm that could be caused by a blown fuse, wiring, sensor, etc.

Q13. What does probe time out error refer to?

A13. There has been a loss of communication between probe and controller. This could be caused by wiring, bad probe, programming, controller, etc.

Appendix A INSTALLING THERMAL PAPER

A.1 Installing Thermal Paper in the Printer

The following procedure provides instructions for replacing the printer's thermal paper. The circled numbers in the diagrams refer to the instruction numbers where parts are identified..

1. Lift printer cover (see Figure A-1).

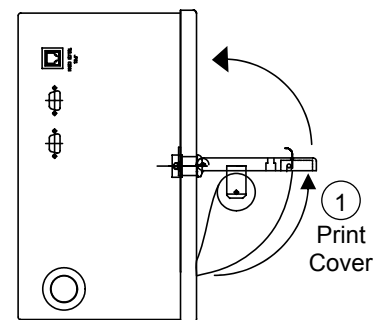

Fig. A-1: Print Cover (Side View)

2. Lift feeder arm (see Figure A-2).
3. Gently remove old paper roll. **Do not discard the core pin.**
4. Slide core pin into center of new paper roll and place into paper bracket.
5. Slide paper edge into the paper feed roller. The feeder will automatically advance the paper.
6. Press feeder button to advance enough paper to slide through paper slot in the printer cover.

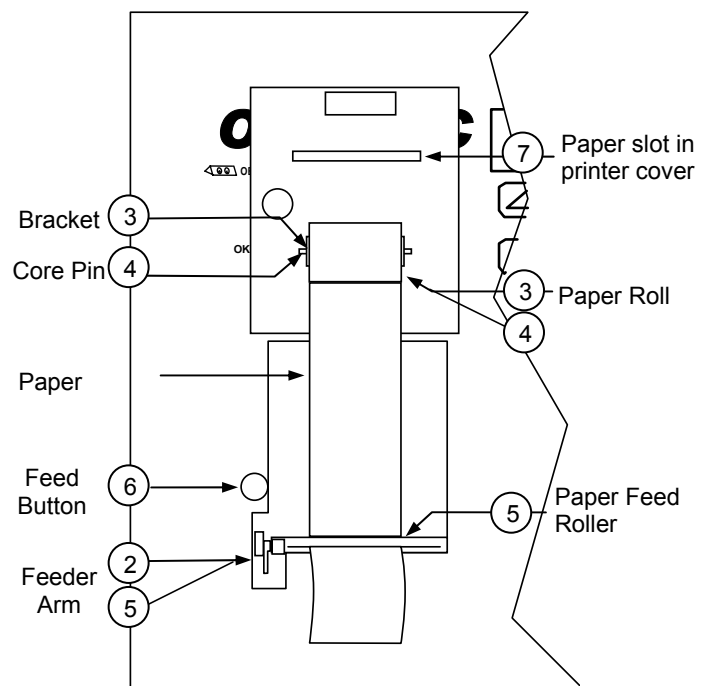

Fig. A-2: Print Cover Open (Front View)

7. While lowering the print cover, feed the paper through its paper slot (see Figure A-3).

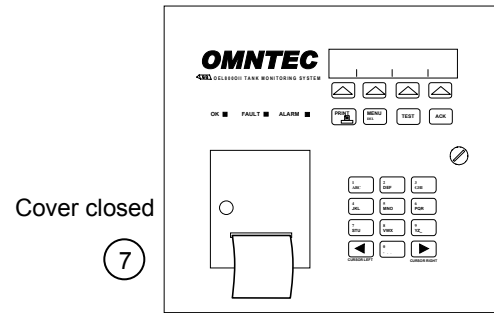

Fig. A-3: Print Cover Closed

Appendix B ELECTRICAL RATINGS

B.1 Electrical Ratings for the OEL8000II

| |
|-------|
| MODEL |
|-------|

OEL8000II

TANK GAUGING LEAK DETECTION
CONTROLLER

SERIAL NUMBER _____



LISTED
5L04

Associated Apparatus; non-hazardous locations; [AEx ia] IIB;
[Ex ia] IIB provides intrinsically safe outputs for use in Class I,
Div.1, Groups C and D or Class I Zone O, Group IIB hazardous
locations when connected in accordance with control drawing number
CDOEL8000II or CDOEL8000II-ENTITY-A.

ELECTRICAL RATINGS

INPUT: 100-240 VAC, 60 W max, 47-63 Hz
OPTIONAL RELAY OUTPUTS: 120 VAC @ 5 A RESISTIVE

ENTITY PARAMETERS

SENSOR INPUT 12 V BARRIERS: $V_{oc} = 12.6$ V, $I_{sc} = 590$ mA,
 C_a (or C_o) = 7.1 μ F, L_a (or L_o) = 410 μ H, $P_o = 1.9$ W
PROBE INPUT 28 V BARRIERS: $V_{oc} = 29.4$ V, $I_{sc} = 65$ mA,
 C_a (or C_o) = 0.5 μ F, L_a (or L_o) = 33 mH, $P_o = 484$ mW

OMNTEC Mfg., Inc. Ronkonkoma, New York

| |
|-------------------------|
| N.Y.F.D. C. of A. #4988 |
|-------------------------|

Made in the U.S.A